

Mitad de un DIN A-3

Utilizar preferiblemente
lámina de dibujo

①

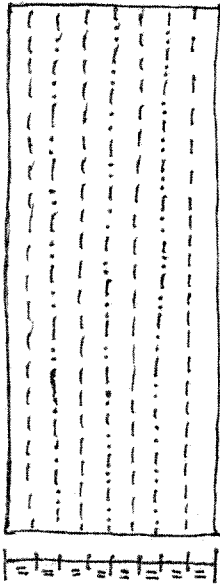

②

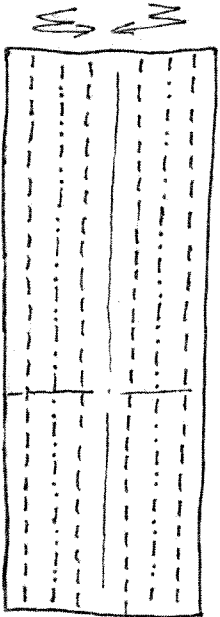
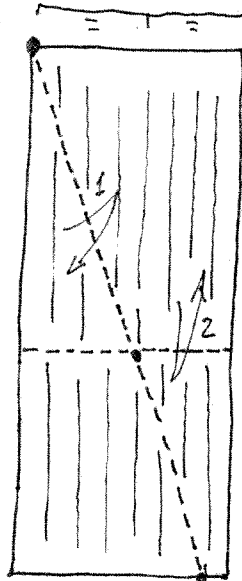

③



④

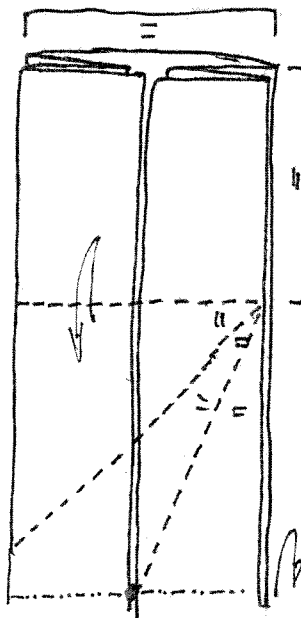

Vista lateral

⑤

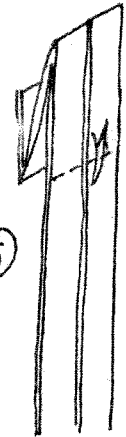

Desmenuar

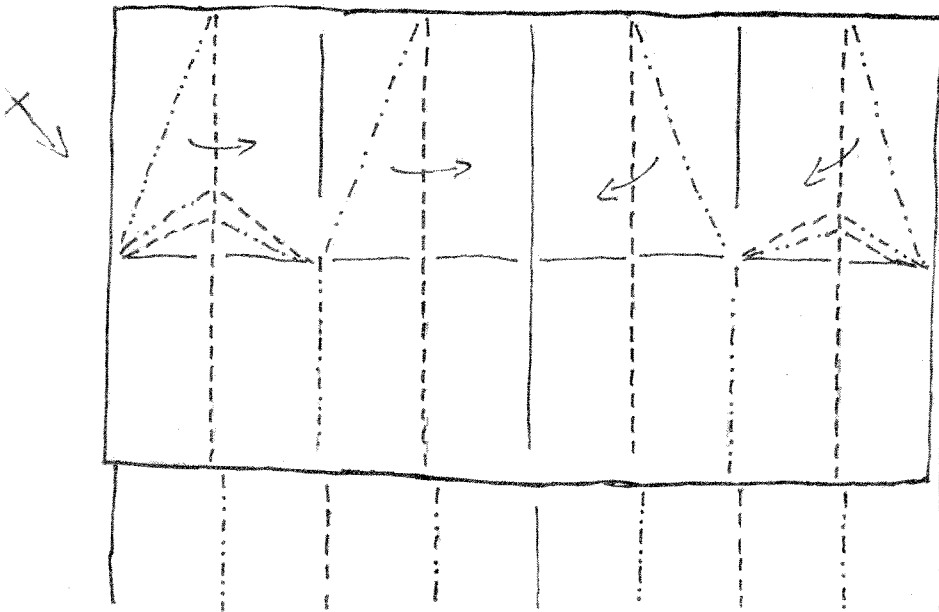
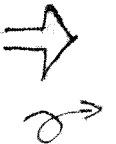

⑥

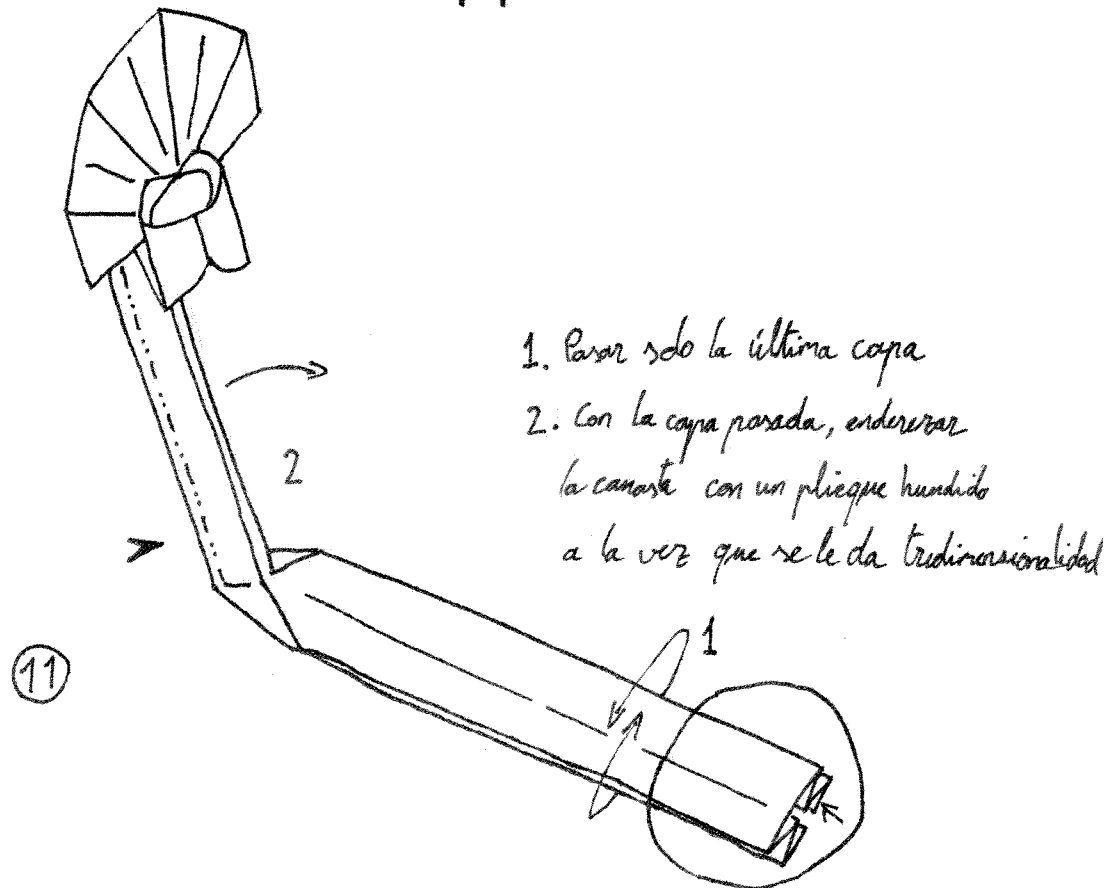
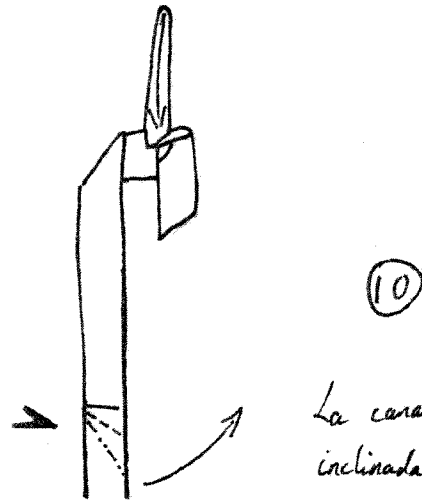
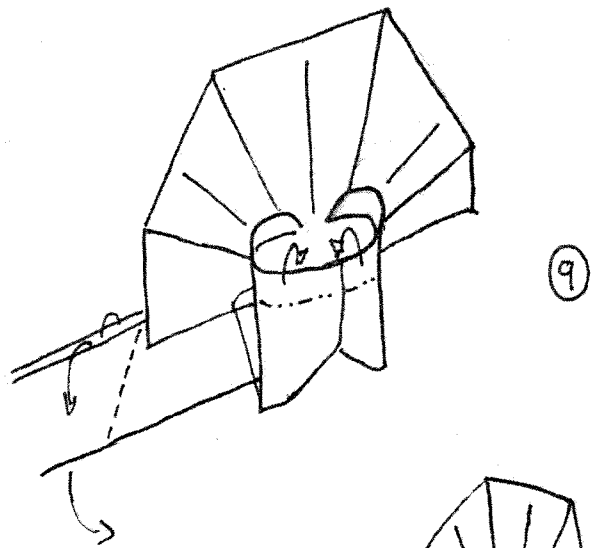
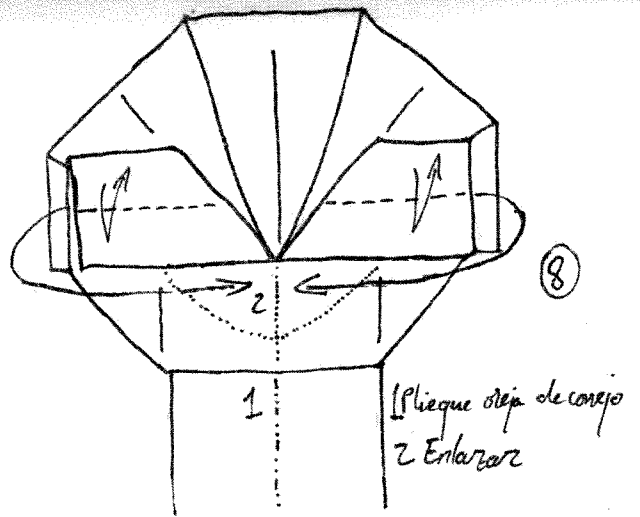
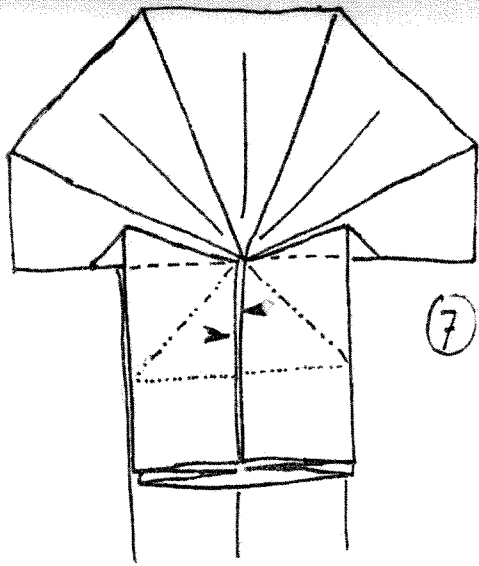

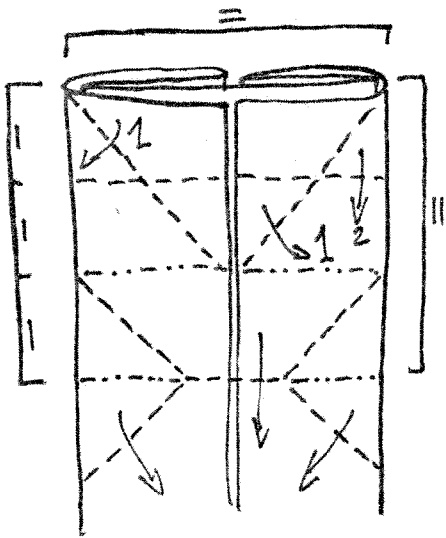

(12)

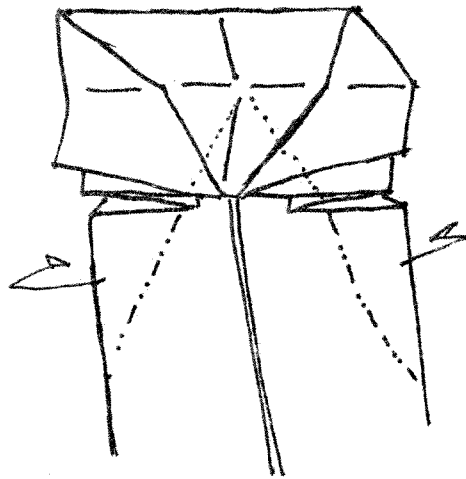

Para reforzar el nudo
podemos hacer un
pliegue adicional

(13)

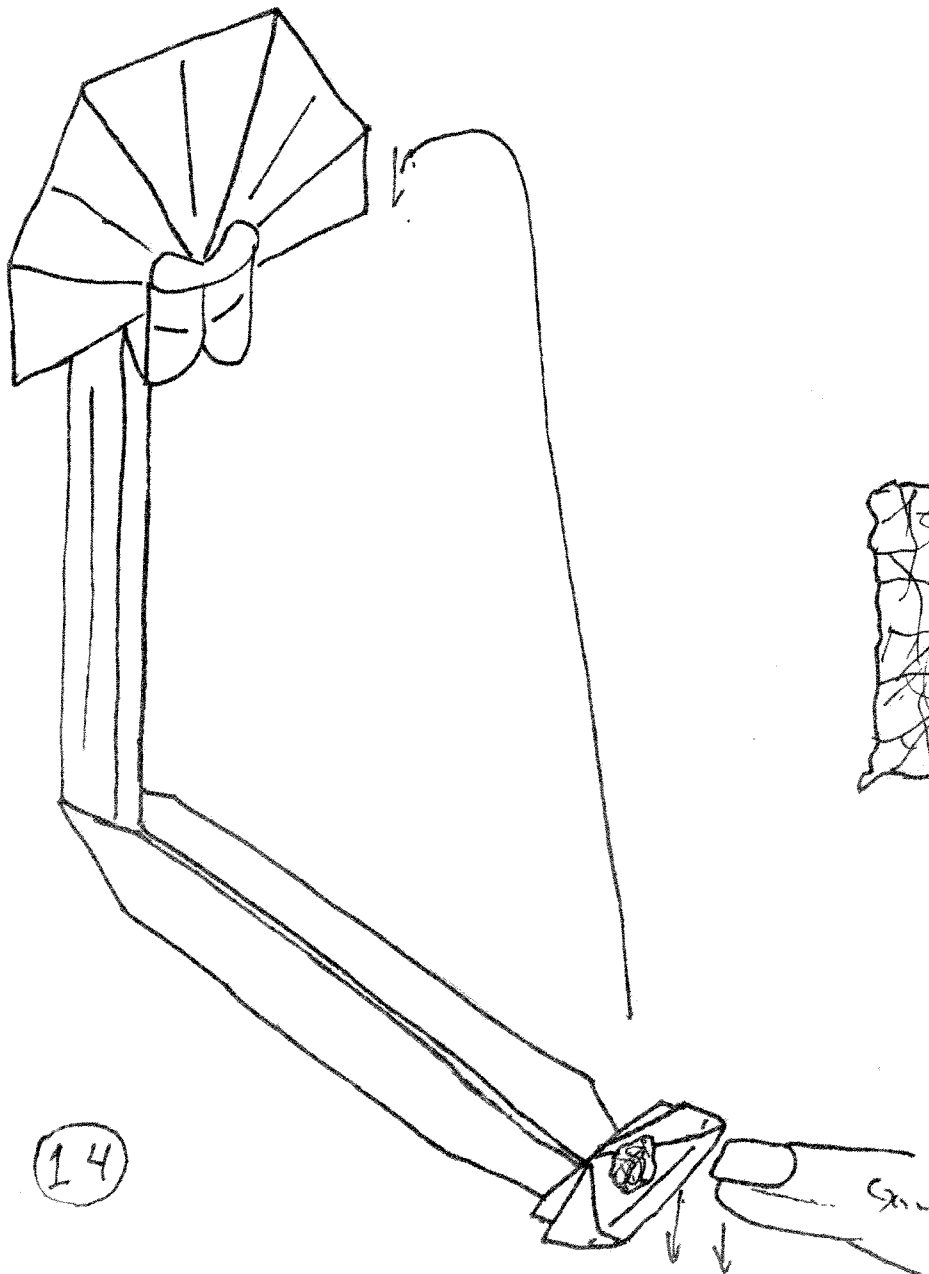

(14)

PELOTA

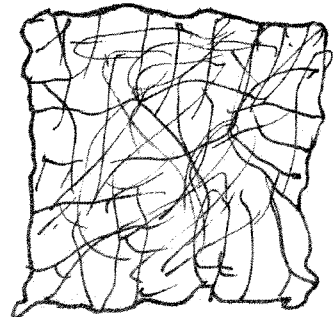

I



II