

ABRACADABRA!

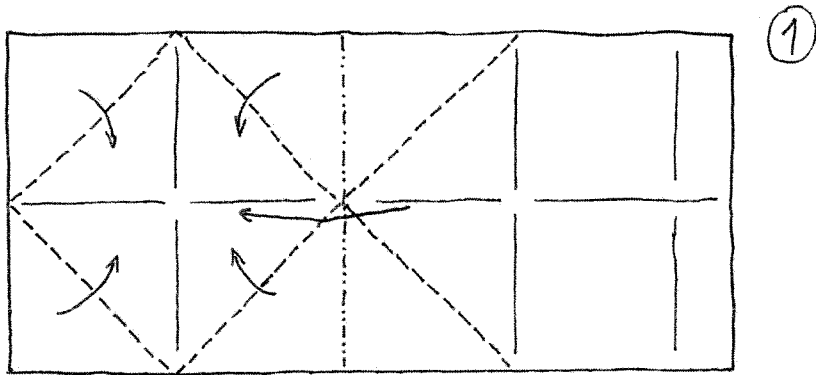

13 x 6

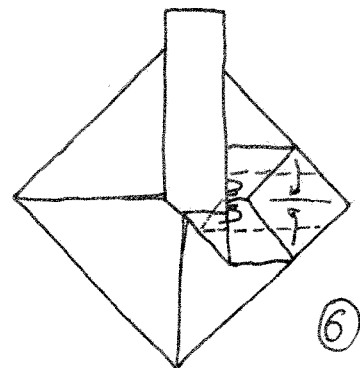

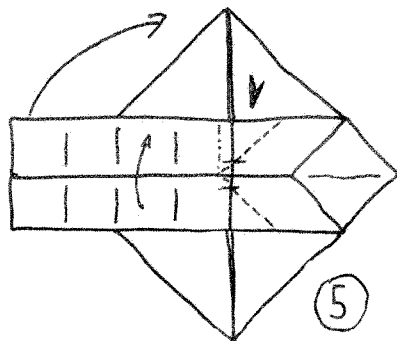
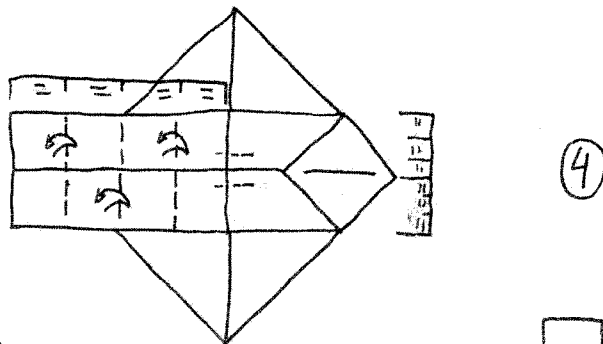
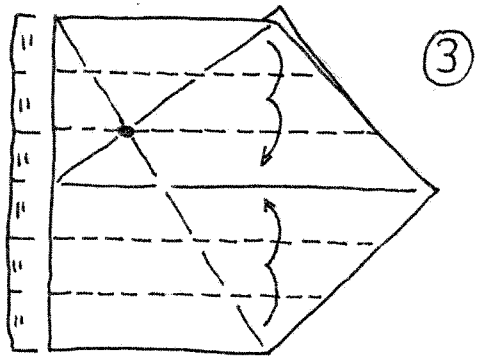
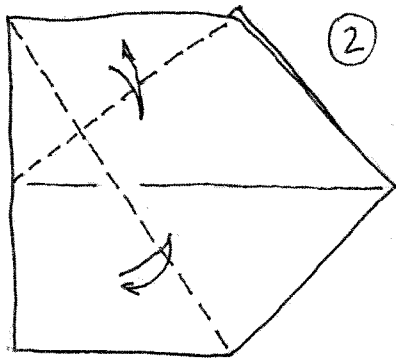
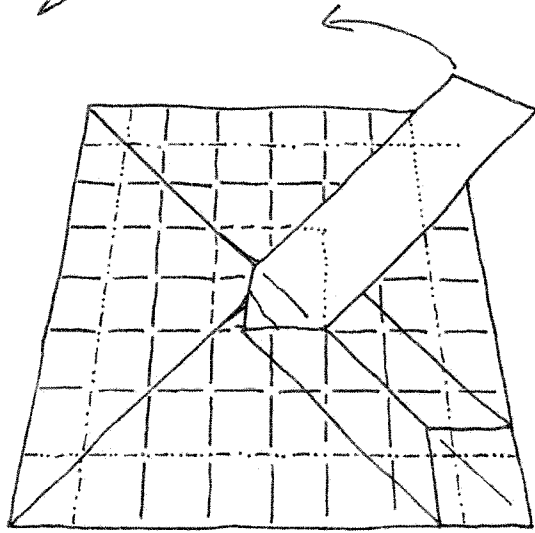

7

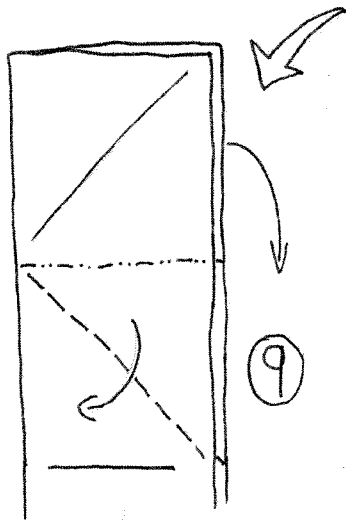

9

8

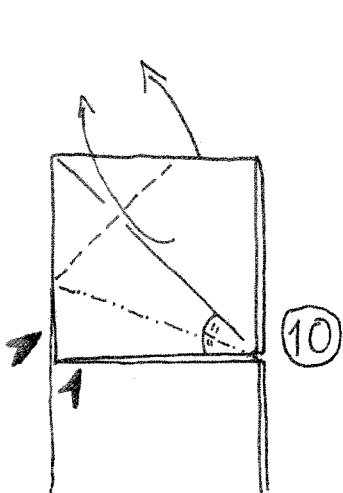
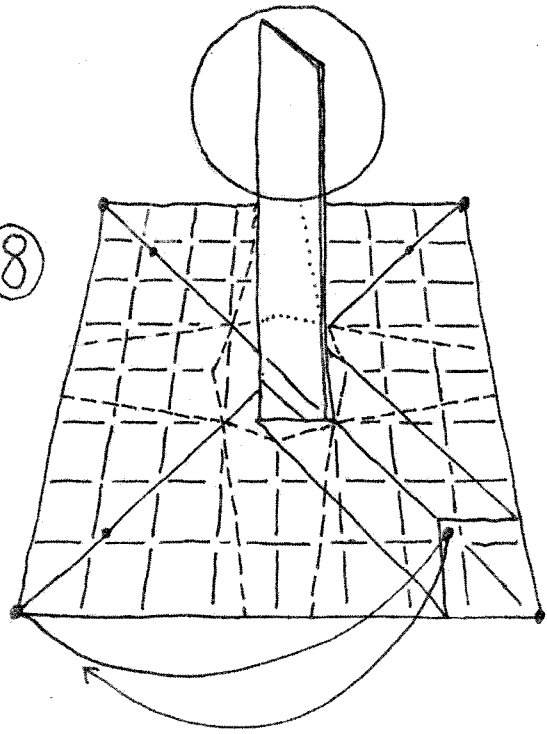

10

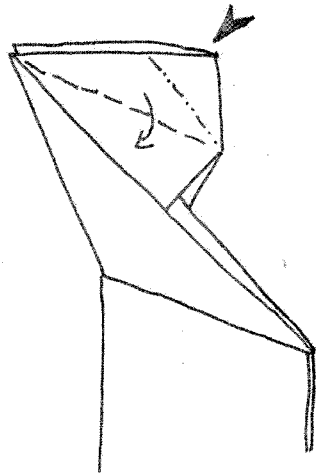

11

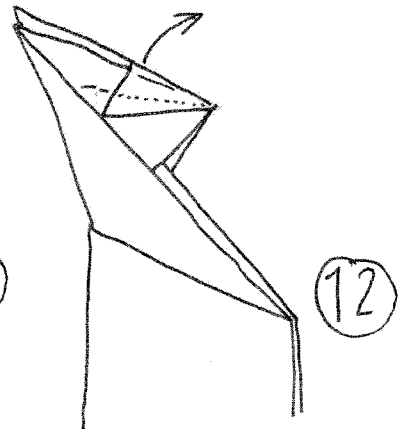

12

22

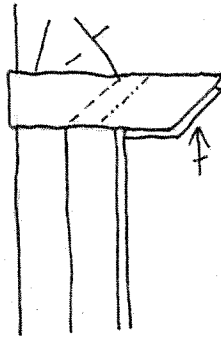
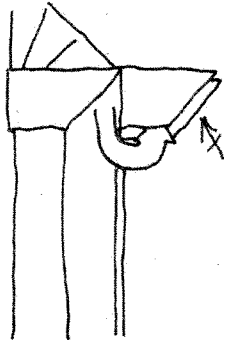

23

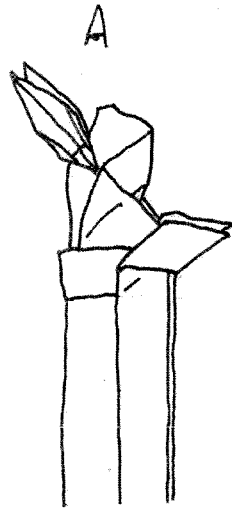

24

25

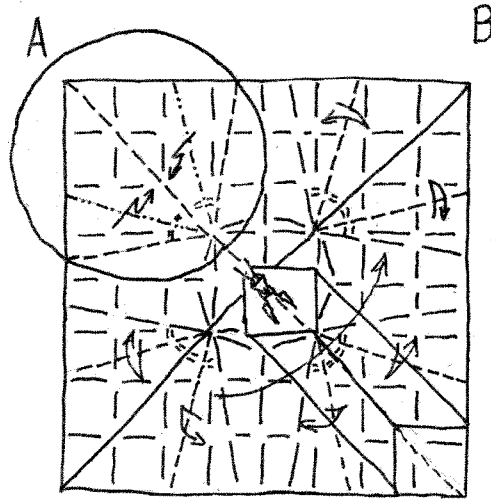

En estos dibujos omitimos el conejo

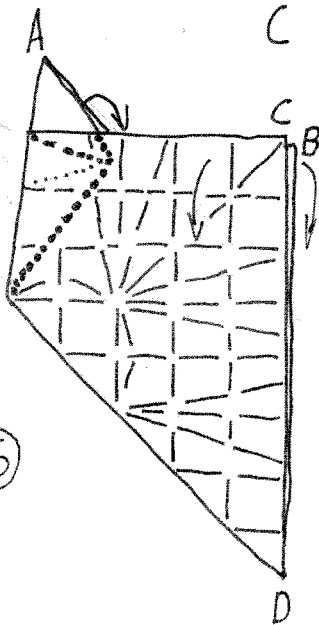

26

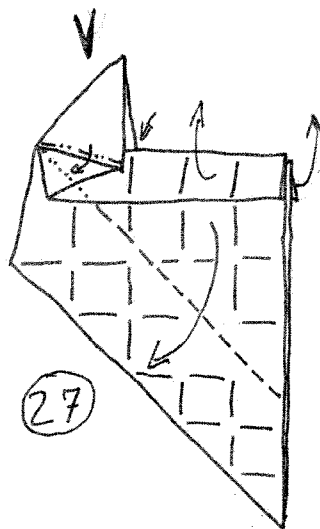

27

Para plegar las puntas B y C sin doblar el conejo, debemos hacerlo "al revés": lo que para la punta A son montañas, para la B y C valles, y viceversa en 25

D En los restantes pasos, plegamos normalmente hasta 30. En este paso plegamos B y C como A

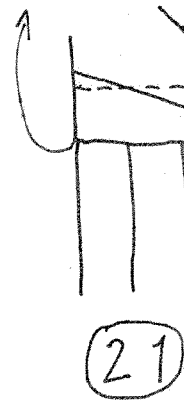
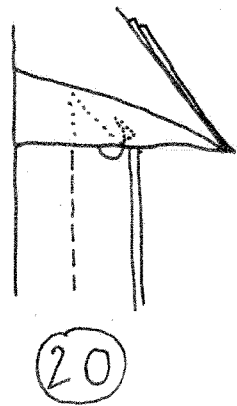
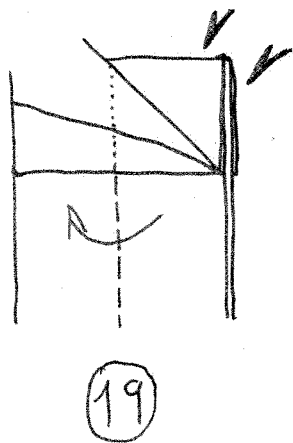
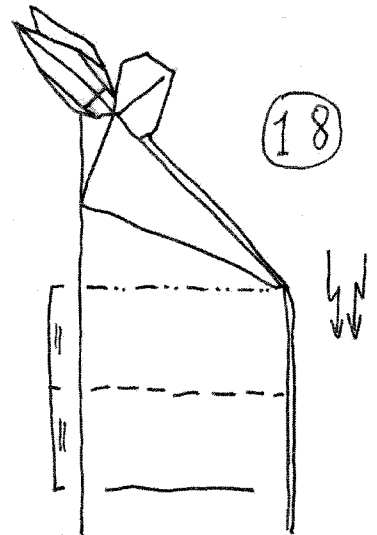
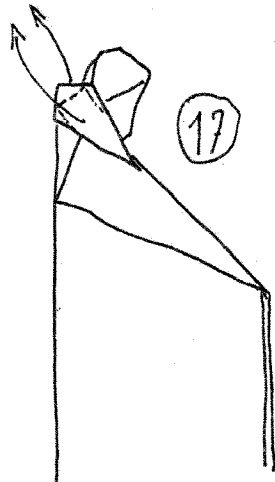
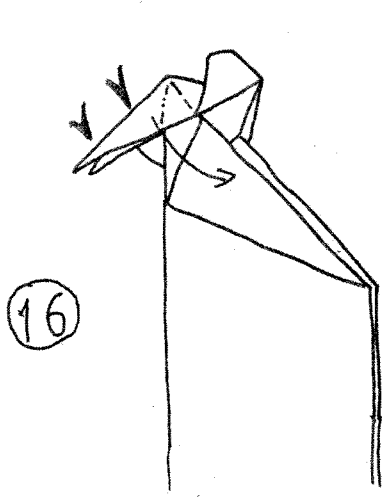
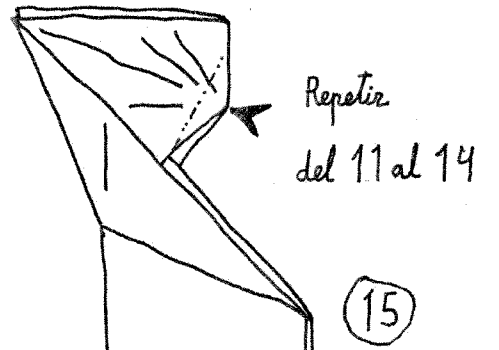
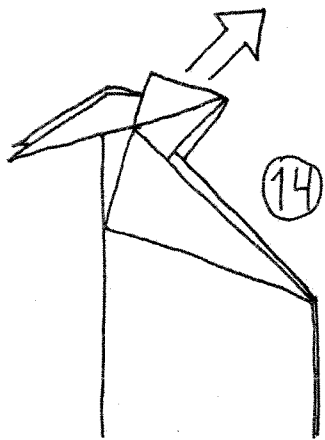
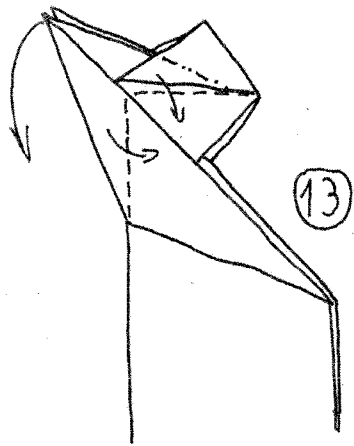

28

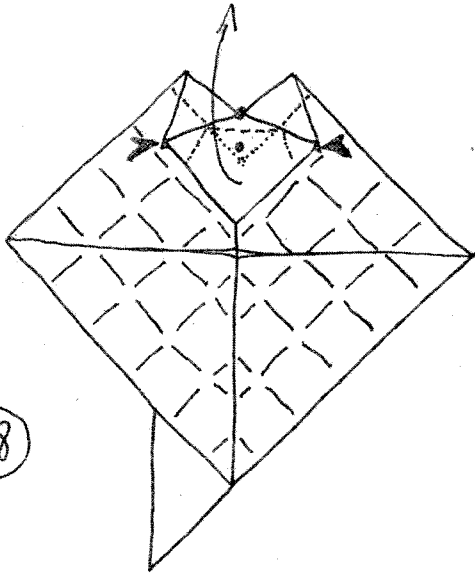

29

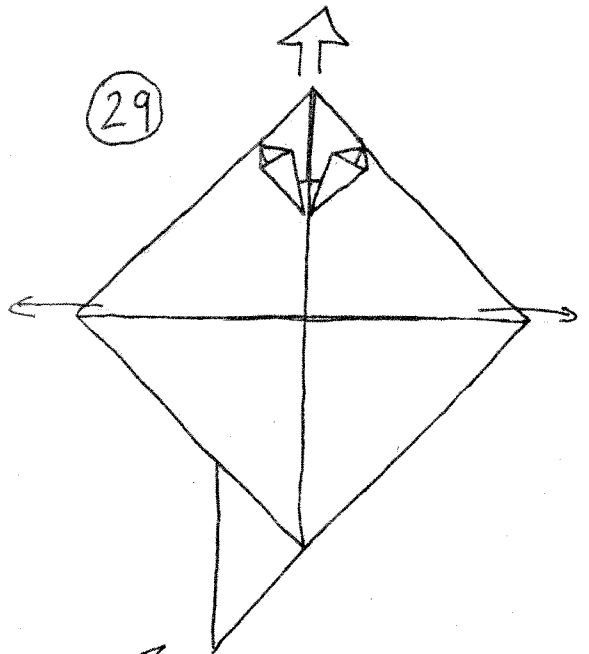

30

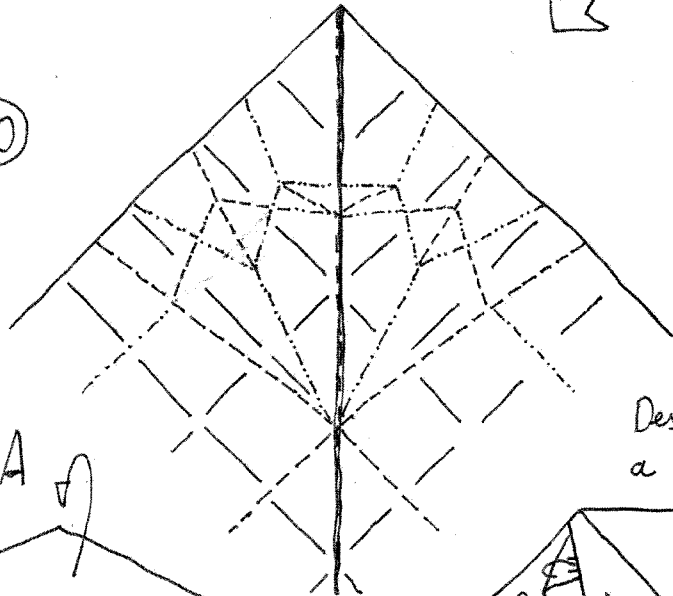

Marcar bien
y deshacer
Repetir en las otras
esquinas 25-30.
Después plegarlas todas
a la vez

31

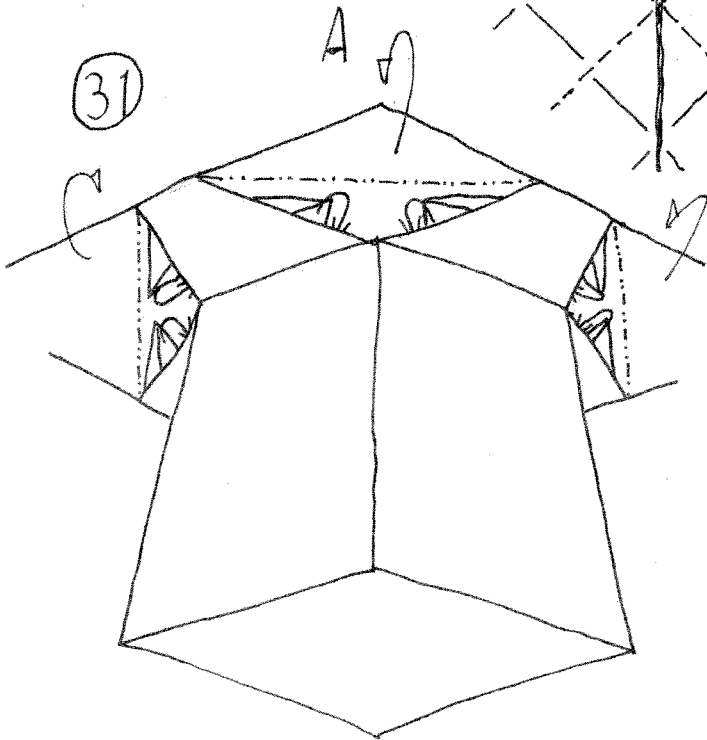

32

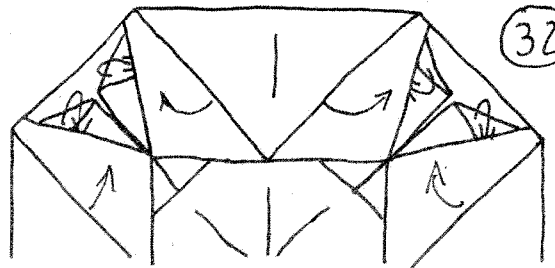

33

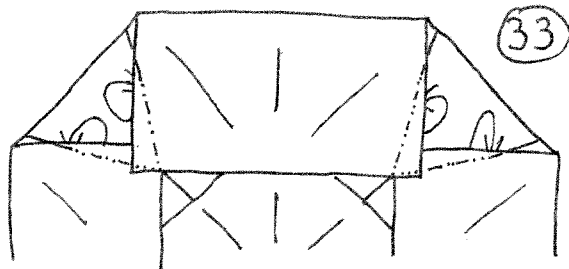

Redondear
la chistera
y pronunciar
las palabras
mágicas

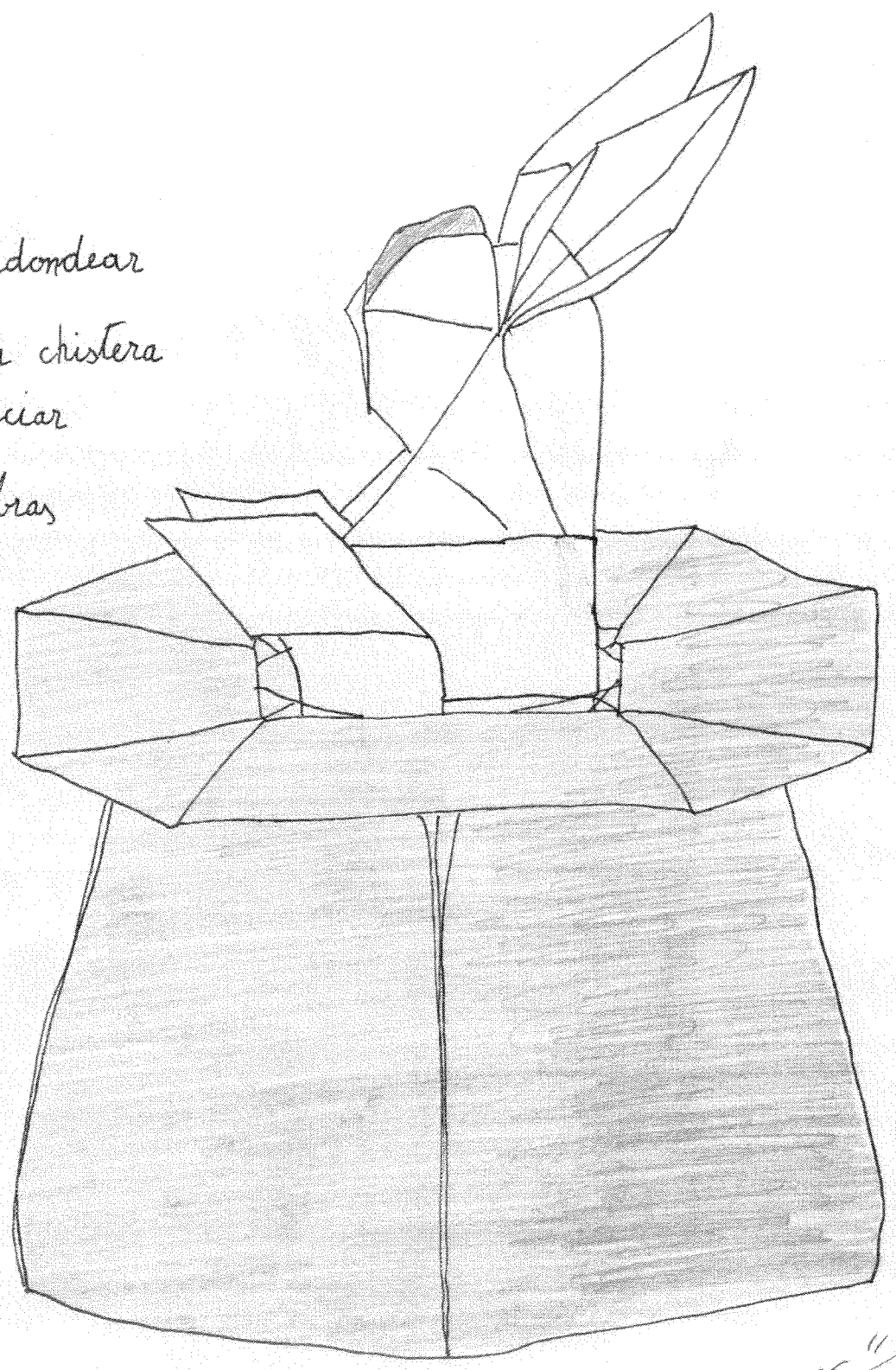

George CC